

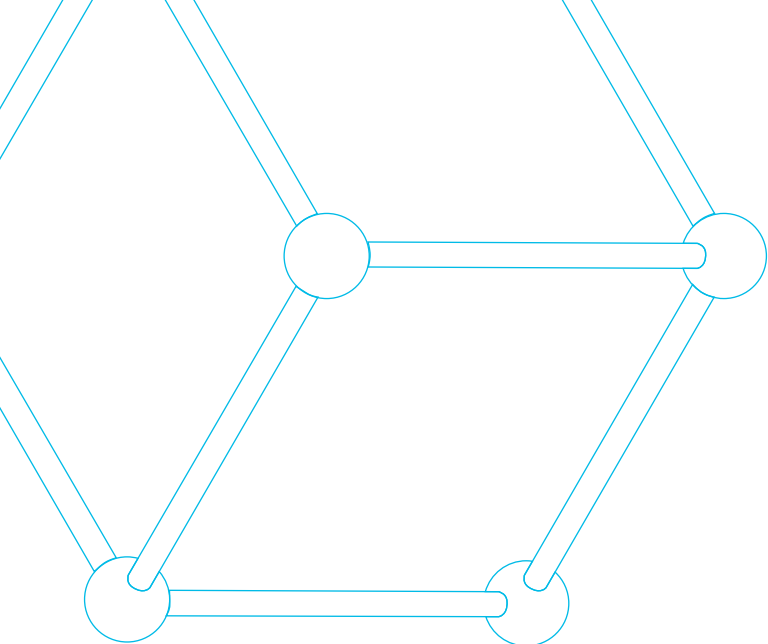

 **LAPPSET**®

LAPPSET PARKOUR
SOLUTIONS



Graphic Design **TYÖMAA**
Text **TYÖMAA, LAPPSET GROUP OY LTD**
CAD-visualisations **LAPPSET GROUP OY LTD**
Photographs **ANTTI KUROLA, JONATHAN BRADY, TIM MILLER**
AND LAPPSET REPRESENTATIVES
Print **ESA PRINT**

W00751

Printed on environmentally friendly paper and in an environmentally friendly printing process.

Copyrights and patents Lappset Group Oy Ltd
All rights reserved © Lappset Group Oy Ltd

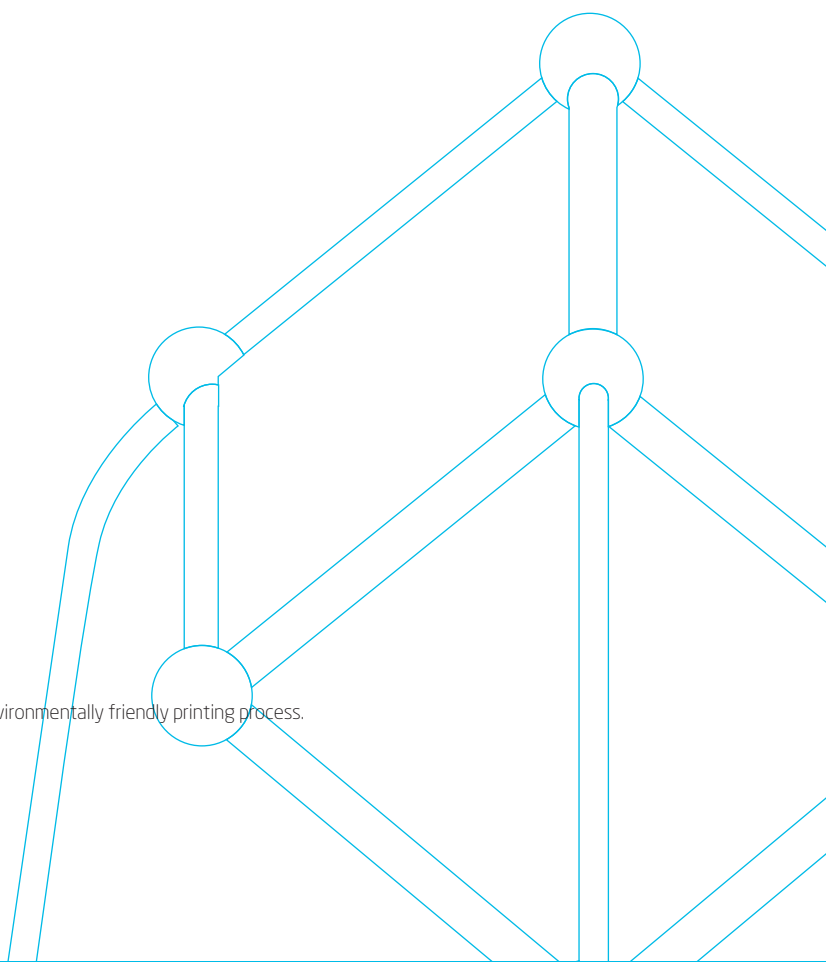

Contents

The new kings of the asphalt jungle are here!	4
From the suburbs to a global phenomenon	5
Traceurs challenge themselves	6
Working with professionals	9
Practice makes perfect	10
A mini parkour dictionary	12
Case London	13
Case Mustasaari	14
Case Uppsala	16
Case Logan	18
Ready-made units for parkour	20
Lappset's parkour products	22
Technical data	33
Warranty periods	34





The new kings of the asphalt jungle are here!

All over the world young people are getting less and less exercise. Games and other electronic entertainment are gluing them to the computer or the sofa indoors and outdoor activity is losing out big time. This lack of outdoor activity and exercise has a knock-on effect, playing a significant role in the onset of various lifestyle diseases

such as type 2 diabetes. Fortunately, deep in the heart of the urban jungle a sport has grown up that appeals even to the most dedicated couch potato. With its spontaneity and street-cred, parkour, the art of fluid movement through an urban environment gets young people moving.

From the suburbs to a global phenomenon

Back in the 1980s a group of friends in the Paris suburbs thought their lives were dull and boring. They spent a lot of time outdoors, jumping, running and climbing. The father of one of them had been a professional soldier. Skilled in various martial arts, he encouraged his son to explore different sports and to develop his own method of movement. The group were innovative and keen and they tried out one discipline after another, put them together, and invented and fine-tuned their moves. And so parkour was born. A sport that is all about pushing your own boundaries and traversing seemingly impossible routes in an urban environment.

Parkour rose to international recognition with our help. Moving through the cityscape with the ease of a cat, the Yamakasi group were featured in countless news items, documentaries and even films. This new way of moving in urban environments instantly caught on with other young people. An active international community of followers and enthusiastic apprentices soon grew up and the sport, focused on physical control and streamlined movements, quickly gained in popularity. One of parkour's best features is that it manages to get young people active who aren't the type to go for sports clubs or the focus on performance of traditional sport.

“ The parkour products were chosen when the local council wanted to encourage young people to get active outdoors. We had help from Lappset in designing the area and choosing the products as there aren't any active parkour groups in our area. The new area has attracted plenty of positive publicity and feedback. Now people are coming here all the way from Turin!

■ Karl Ties, Head of sales, Euroform, Italy





Traceurs challenge themselves

Although the number of people who practise parkour, known as traceurs, is now almost impossible to estimate, the sport still retains the elements defined by its original inventors. One of the aims of parkour is to improve your own ability in the long term, which also encourages traceurs to look after their own bodies. Parkour is not competitive. The most important thing is finding your own limits and pushing yourself to the

utmost. In parkour the only person you are competing against is yourself.

In some countries, however, practitioners of the sport came up against an insurmountable obstacle – the unique nature of the moves and the unusual places in which they practise them saw the hobby deemed to be a criminal offence. An area containing Lappset's parkour



products offers practitioners a place to practice, designed by experts in the sport, where fine-tuning moves is definitely safe and allowed. Because the area offers challenges even for those with advanced skills, it is also excellent at fostering the sense of community that is an essential part of the sport. When people with varying abilities get together, those who are more expert can serve as examples to the younger ones, and they do so in more than just parkour.



Working with professionals

Lappset's parkour products are safe for beginners while also offering plenty of challenges for advanced users. Different levels of skill were taken into account as early as the planning stage, as professionals in the sport were on board throughout product development. Experienced guides from the Finnish Parkour Academy have already passed their skills on to thousands of children and young people. Thanks to their in-depth expertise, the equipment really does match the needs of traceurs.

Parkour is all about smooth, uninterrupted movement. This means that the practice areas have to be designed so that the equipment creates interesting routes for the users. In designing routes particular attention must be paid to the distances between the equipment and the position of the various elements in relation to each other. Designing a parkour area is an excellent opportunity to kick-start a relationship with local

traceurs. If this isn't possible, however, there is always the option of choosing a suitable ready-made design for your site instead. In designing the site you can also call on the expertise of Lappset's MyDesign team, whose designers work in close cooperation with parkour professionals.

Download tutorial videos into your own mobile phone

So that not a single potential traceur falls at the first fence, all Lappset parkour products come with a virtual guide. The virtual guide launches using the ID on each product via your mobile phone camera. The ID downloads the instruction video to the user's phone from the internet where a professional in the sport provides instructions on learning the moves correctly and safely. Signs can also be provided for parkour areas showing the same instructions with simple drawings.

“ Working in partnership with local parkour fans means we can help our customers to raise awareness of the sport and get more people using the new equipment. When they order from us, customers get a parkour active guide, a group website for local users and maybe a package of materials advertising the new area. We'd definitely recommend working with your local parkour experts!

■ Harrie Kerkhof, Sales and marketing manager, Yalp, the Netherlands





Practice makes perfect

Parkour is all about creative moves, physical control and interacting with your environment. The best part about the sport is that you can start it anywhere and at any time. And you don't need any previous sporting ability either. You begin with small, simple actions, repeating them to progress to more challenging and complex moves. However complicated the moves, the motivation is the same – the main aim of parkour is to have fun.

The principle of moving from simple to challenging is shown in the videos by Lappset's virtual guide. Each training video starts with a basic exercise before moving on to harder moves and then to a complete series of moves. The videos show what users of the equipment should concentrate on and what not to do using clear visual signs. As well as the basic moves, the virtual guide also takes you through an extensive initial warm-up. Here we present a selection of some of the complex moves that the sport involves:

UNDERBARS

Underbars are moves for passing through, under or around obstacles. The underbar technique is usually used for slipping between two horizontal obstacles. The move is made with either your legs or arms and your upper body first. Guiding your body through small spaces exercises all the most important muscle groups.

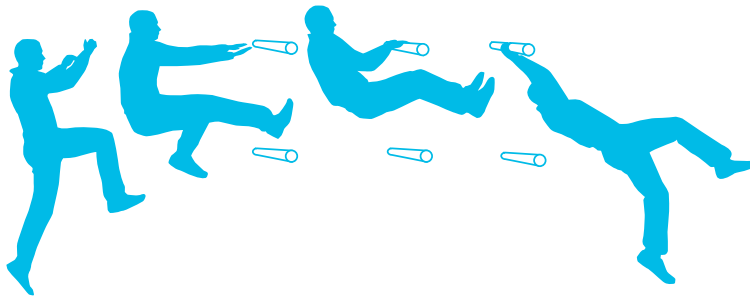

Practise underbars on these:
220552 VAULT CAGE M



Meet your virtual guide!
Read the code on your phone camera.*

LACHÉ

Laché covers all the moves where you hang, swing and let go to take your hands or feet on to the next hold. Swinging and hanging moves are used to move using your hands from one level to another or to swing into other moves. They also strengthen hands, shoulders, upper back and develops a firm grip.



Practise lachés on these:
220513 GIBBONSWING L



Meet your virtual guide!
Read the code on your phone camera.*

TIC TAC

Traceurs treat walls as if they were floors. In the tic tac move you stand on a vertical surface and push off it to other obstacles or over them. Tic tac is usually combined with other parkour moves such as vaults and precision jumps.

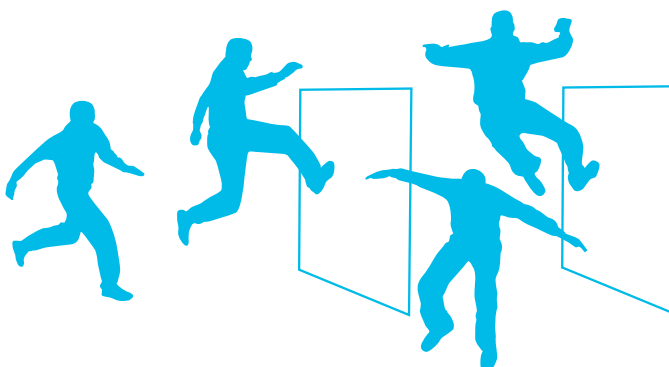

Practise tic tac here:
220523 SPIDER CAGE M

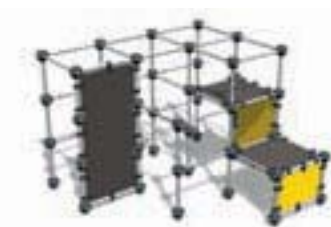

Meet your virtual guide!
Read the code on your phone camera.*

*Download reader from: www.upcode.mobi

A mini parkour dictionary

L'art du déplacement

The first name for the sport, literally the art of movement.

Parkour

The word was developed by one of the first practitioners of the sport in 1998. It comes from the French word *parcours*, which means route or course.

Freerunning

Parkour was introduced to the English speaking world under the name of freerunning in 2003. Today freerunning is a form of parkour which also incorporates acrobatic elements.

Saut de fond - Drop jump

Dropping. Big drops are one of the most spectacular moves in parkour.

Roulade - Roll

A roll to protect the body of the traceur performed after a jump from a height and after a high-speed drop to lead into the next move.

Passement - Vault

Moving over an obstacle without stopping running.

Réception - Landing

Landing after a jump, drop or vault.

Passe muraille - Wall run

Passing an obstacle by pushing off from a wall and grabbing the top of the wall with your hands.

Saut de bras - Cat leap/Arm jump

Jump or drop in which you grab the edge of the obstacle with your hands and drop to the wall or your legs stay on the vertical surface of the wall.

Franchissement - Clearing

Movements where you dive or pull your body in one fluid movement under or around the bar.

Saut de chat - Monkey vault

A vault where your hands grab the top of the obstacle and then pull your body over the obstacle.

Tic tac

An upwards take-off used to clear obstacles that are too high to jump.

Équilibre - Balance

Balancing. Good balance and awareness of the position of the body make moves easier.

Laché - Swings/Laché

Hanging moves where you hang from one spot, swing and let go and grab the next hold.



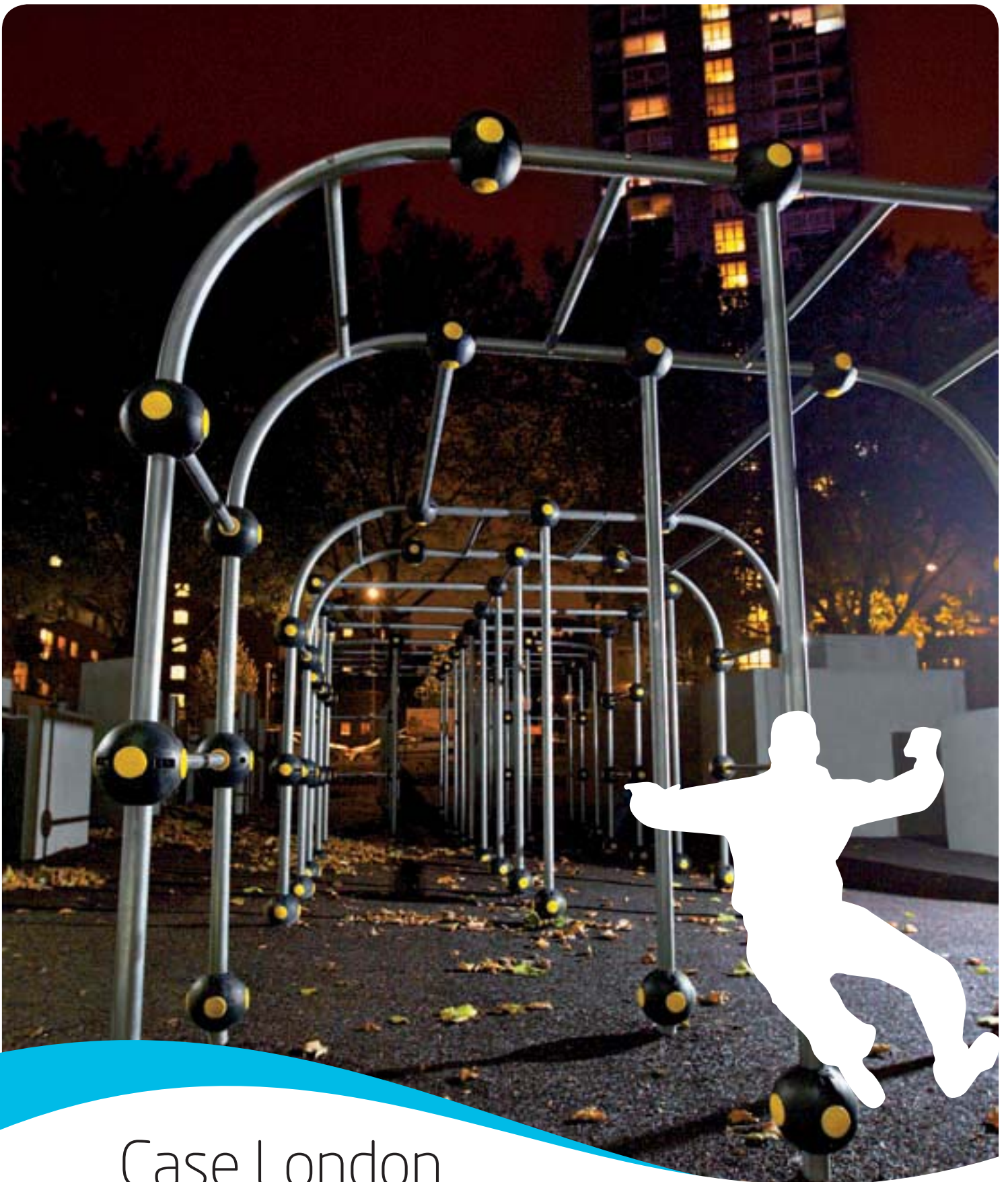

Case London

■ Westminster Academy Sports Centre, London, UK.

The world's biggest parkour area is currently being built in London. When it's finished the area will provide facilities for teaching the sport to beginners, and for more expert independent users. Lappset's parkour equipment is perfect for the area as thanks to its modular design it can be tailored

to suit local needs. And the quality of the equipment was impressive too. We already know that the area is going to get a lot of use. Lappset's parkour products will definitely stand the pace and remain safe.

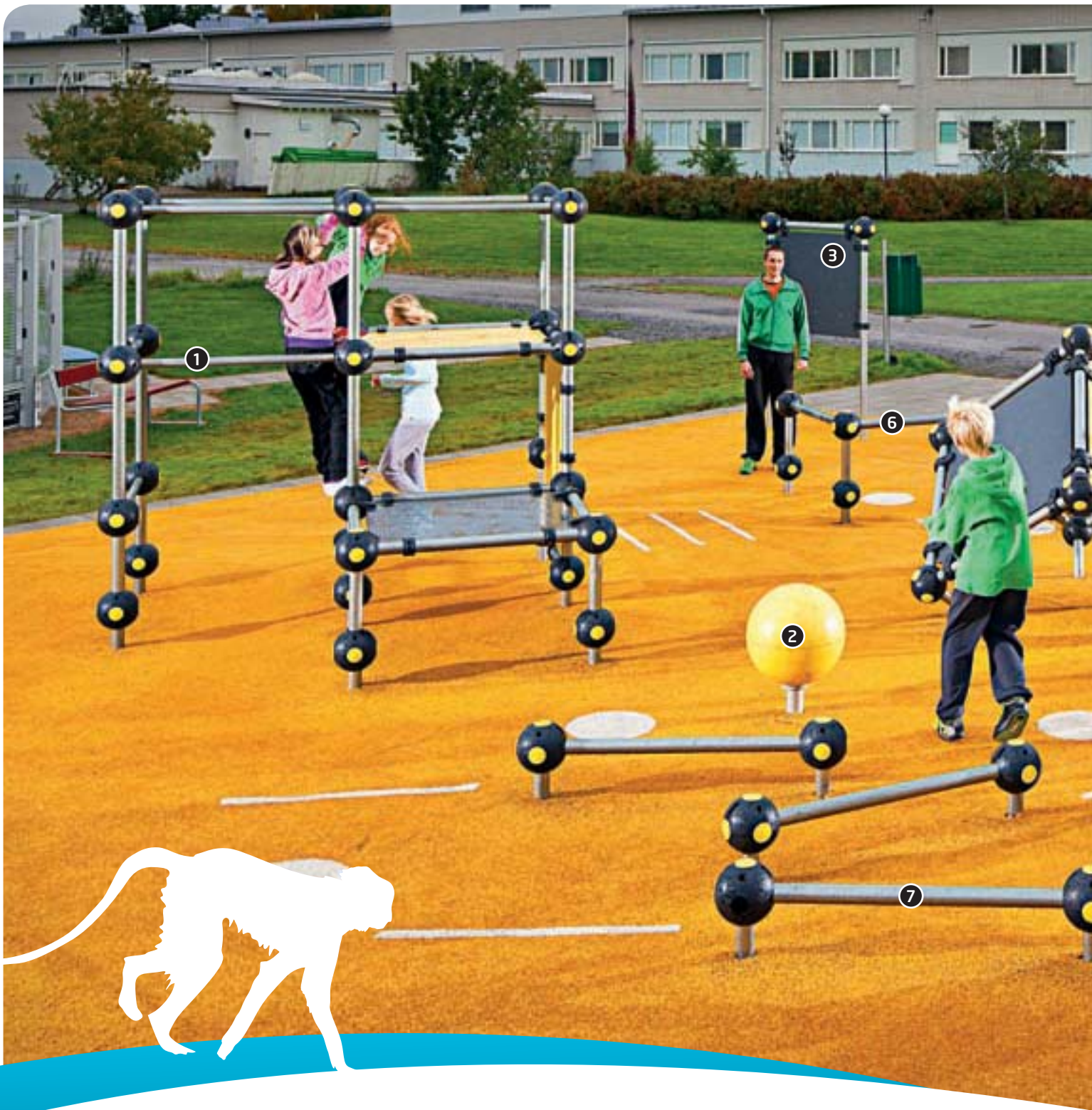

Case Mustasaari

■ Mustasaari school, Mustasaari, Finland

We knew that the school yard needed more exercise options. When the local authority gardens officer discovered Lappset's parkour products, that was it. No other solution was even considered. The equipment has been a major hit with the kids. The parkour area is in active use in the evenings and at weekends as well as in school breaks. The advantage of parkour products is clearly the way they work for different ages and levels of ability. Moves and tricks are easy to learn but sufficiently challenging at the same time.



1 220520 SPIDER CAGE S

2 220501 & 220502 PRECISION BALL

3 220590 SIGN

4 220530 TIC-TAC CUBE S

5 220510 GIBBON SWING S

6 220547 VAULT RAILS S

7 220539 & 220540 PRECISION BAR



Case Uppsala

■ Eriksberg, Uppsala, Sweden

In this park designed for all local residents, we wanted to create an entity that would bring the generations together and offer stimulating outdoor exercise for everyone. As well as a parkour area, the park also has a playground, exercise equipment, a Senior Sport area and a Panna arena. This means children can play and exercise while their parents or grandparents do the same. The park's parkour area is really popular and the equipment is nearly always full. An over ten-year age difference doesn't bother anyone in the slightest. You can always learn something new from other people.



① 220523 SPIDER CAGE M

② 220501 & 220502 PRECISION BALL

③ 220505 PYRAMID CLIMBER

④ 220513 GIBBONSWING L

⑤ 220531 TIC-TAC CUBE M

⑥ 220548 VAULT RAILS M

⑦ 220539 & 20540 PRECISION BAR



Case Logan

■ Riverdale Park, Meadowbrook, Logan, Australia

Riverdale Park is a big public park owned by the city of Logan, designed for the use of local residents. The park has a huge parkour area with equipment for younger and older fans of the sport. The areas for both user groups only use Lappset parkour products. Because there is plenty of space, there are plenty of products too, including a total of four precision balls, Spider Cage, Tic Tac Cube and a Gibbon Swing



① 220523 SPIDER CAGE M

② 220501 & 220502 PRECISION BALL

③ 220505 PYRAMID CLIMBER

④ 220531 TIC-TAC CUBE M

⑤ 220513 GIBBONSWING L

⑥ 220548 VAULT RAILS M

⑦ 220590 SIGN

⑧ 220539 & 220540 PRECISION BAR



Ready-made units for parkour

Lappset's parkour equipment has been developed in collaboration with true experts – active traceurs – who also helped to construct our sample layouts. What is important in parkour is to practise different series of movements so that they can be performed smoothly. This is why areas for parkour practice must be designed with the requirements of the sport in mind.

The smaller example on these pages is intended for beginners and younger traceurs. Although the amount of equipment is limited, it offers a variety of functions.

The larger areas pose challenges for older and more experienced enthusiasts. When designing your parkour area you can contact Lappset's MyDesign! service. We consult parkour professional about each project to ensure that the area meets its users' needs.

Please find three examples of areas from an array of Lappset's ready-made area designs. Additional solutions are to be found on our website, for e.g. 220592, 220593, 220595.



220591

- 1 **220523** SPIDER CAGE M
- 2 **220531** TIC TAC CUBE M
- 3 **220510** GIBBONSWING S
- 4 **220547** VAULT RAILS S
- 5 **220502** PRECISION BALL
- 6 **220540** PRECISION BAR
- 7 **220539** PRECISION BAR EXTRA PART





220594

- 1 220523 SPIDER CAGE M
- 2 220590 SIGN
- 3 220513 GIBBONSWING L
- 4 220502 PRECISION BALL
- 5 EU0600B FUN BANK
- 6 220548 VAULT RAILS M
- 7 220505 PYRAMID CLIMBER

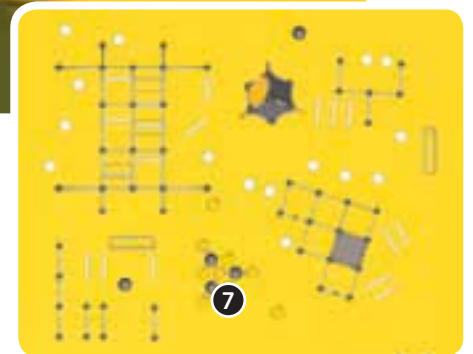

220596

- 1 220560 WALL XS
- 2 220511 GIBBONSWING M
- 3 220524 SPIDER CAGE M
- 4 220590 SIGN
- 5 220564 WALL COMBINATION M
- 6 220552 VAULT CAGE M
- 7 220503 LAUNCH BOX
- 8 220538 PRECISION BAR LONG
- 9 220501 PRECISION BALL





220510 GIBBONSWING S

Safety zone > 600 mm	32m ²
Fall height	1760 mm
Certificates	EN 1176-1, 2:2008 TÜV
User age	Over 6 years
Installation time, 2 people	6,5h
Mounting alternatives	Deep and surface mounting

1:200

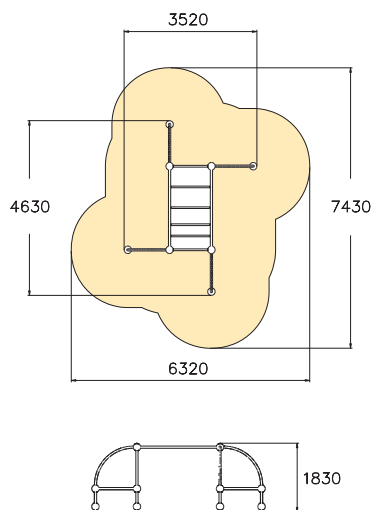

NEW PRODUCT!

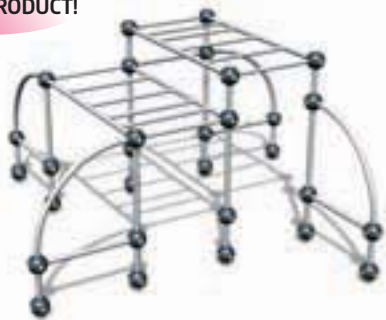

220511 GIBBONSWING M

Safety zone > 600 mm	39.5m ²
Fall height	2230 mm
Certificates	EN 1176-1, 2:2008 TÜV
User age	Over 6 years
Installation time, 2 people	10h
Mounting alternatives	Deep and surface mounting

1:200

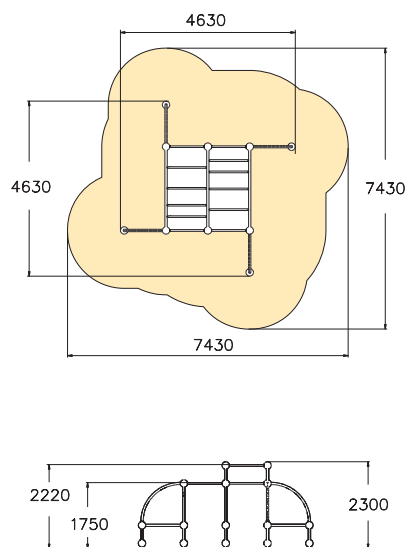

220513 GIBBONSWING L

Safety zone > 600 mm	44.4m ²
Fall height	2650 mm
Certificates	EN 1176-1, 2:2008 TÜV
User age	Over 10 years
Installation time, 2 people	6h
Mounting alternatives	Deep and surface mounting

1:200

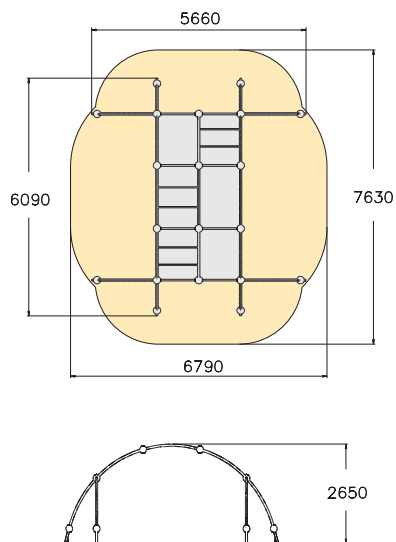

NEW PRODUCT!

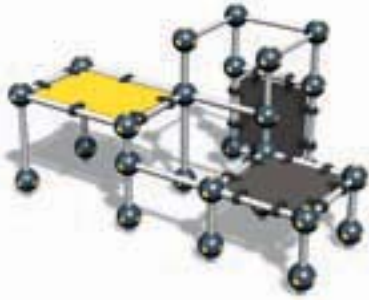

220517
SPIDER CAGE XS

Safety zone > 600 mm	22.1m ²
Fall height	1435 mm
Certificates	EN 1176-1, 2:2008 TÜV
User age	Over 6 years
Installation time, 2 people	8h
Mounting alternatives	Deep and surface mounting

1:200

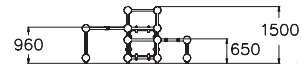
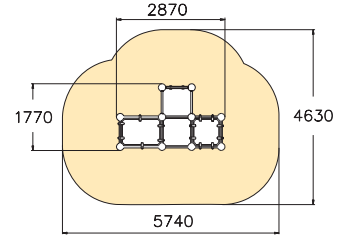

220520
SPIDER CAGE S

Safety zone > 600 mm	30.4m ²
Fall height	2210 mm
Certificates	EN 1176-1, 2:2008 TÜV
User age	Over 6 years
Installation time, 2 people	9h
Mounting alternatives	Deep and surface mounting

1:200

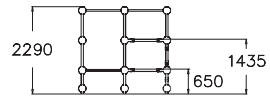
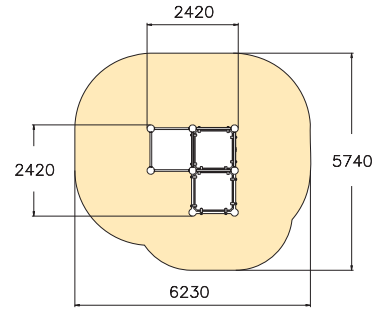

220523
SPIDER CAGE M

Safety zone > 600 mm	45.4m ²
Fall height	2530 mm
Certificates	EN 1176-1, 2:2008 TÜV
User age	Over 10 years
Installation time, 2 people	15,5h
Mounting alternatives	Deep and surface mounting

1:200

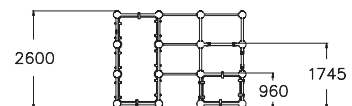
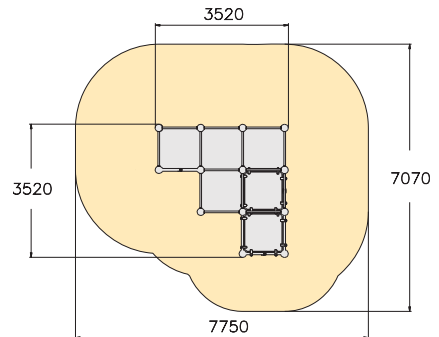



220526 SPIDER CAGE L

Safety zone > 600 mm	72.7m ²
Fall height	2530 mm
Certificates	EN 1176-1, 2:2008 TÜV
User age	Over 10 years
Installation time, 2 people	29,5h
Mounting alternatives	Deep and surface mounting

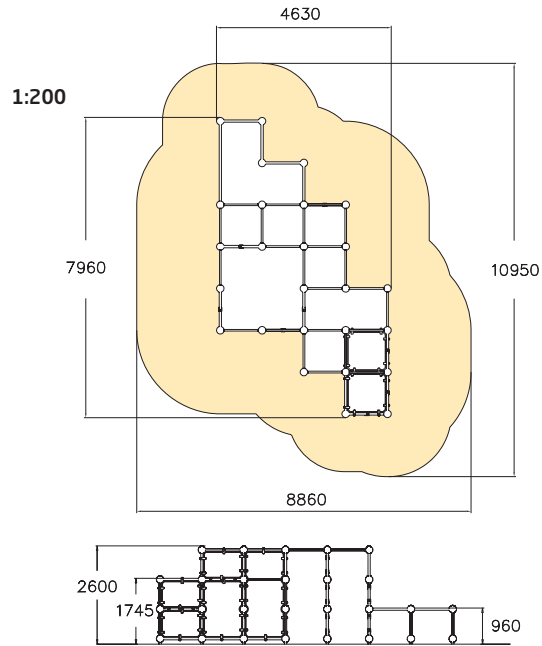

220530 TIC-TAC CUBE S

Safety zone > 600 mm	15m ²
Fall height	1550 mm
Certificates	EN 1176-1, 2:2008 TÜV
User age	Over 6 years
Installation time, 2 people	3h
Mounting alternatives	Deep and surface mounting

1:200

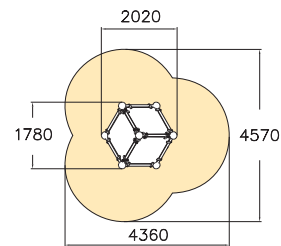

220531 TIC-TAC CUBE M

Safety zone > 600 mm	17.8m ²
Fall height	2190 mm
Certificates	EN 1176-1, 2:2008 TÜV
User age	Over 10 years
Installation time, 2 people	3,5h
Mounting alternatives	Deep and surface mounting

1:200

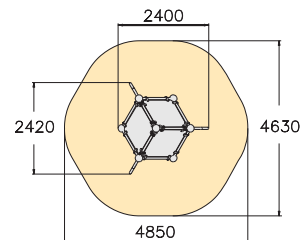

NEW PRODUCT!

1:200

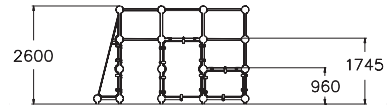
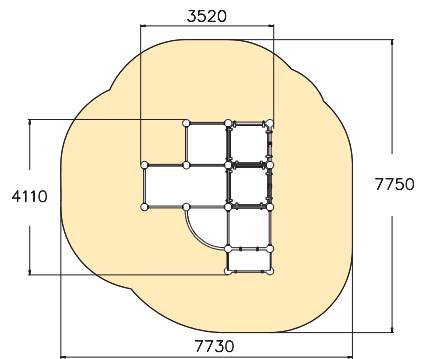

220524
SPIDER CAGE M

Safety zone > 600 mm	48.7m ²
Fall height	2530 mm
Certificates	EN 1176-1, 2:2008 TÜV
User age	Over 10 years
Installation time, 2 people	14,5h
Mounting alternatives	Deep and surface mounting

NEW PRODUCT!

1:200

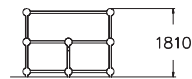
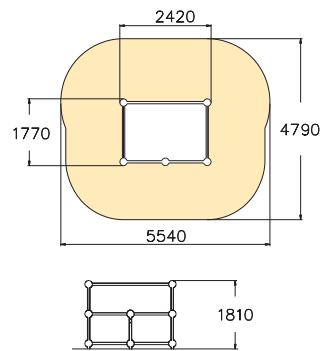

220552
VAULT CAGE M

Safety zone > 600 mm	23.6m ²
Fall height	1745 mm
Certificates	EN 1176-1, 2:2008 TÜV
User age	Over 10 years
Installation time, 2 people	3,5h
Mounting alternatives	Deep and surface mounting

NEW PRODUCT!

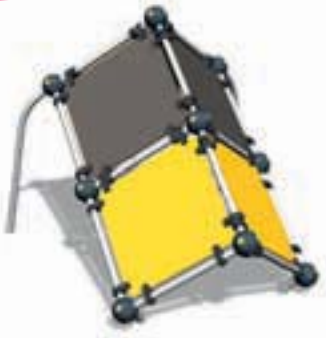

1:200

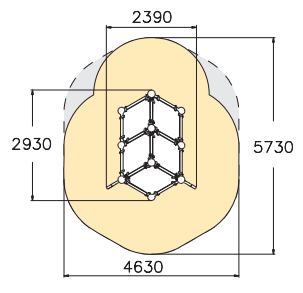

**220532
TIC-TAC CUBE L**

Safety zone > 600 mm	20.2m ²
Fall height	2180 mm
Certificates	EN 1176-1, 2:2008 TÜV
User age	Over 6 years
Installation time, 2 people	4,5h
Mounting alternatives	Deep and surface mounting

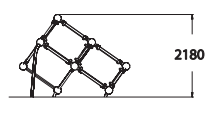

NEW PRODUCT!



1:200

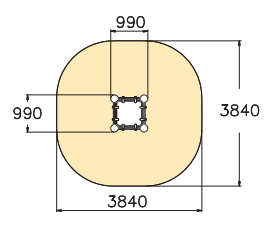

**220503
LAUNCH BOX**

Safety zone > 600 mm	12.8m ²
Fall height	650 mm
Certificates	EN 1176-1, 2:2008 TÜV
User age	Over 1 years
Installation time, 2 people	2,5h
Mounting alternatives	Deep and surface mounting

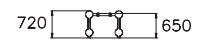

1:200



**220501 & 220502
PRECISION BALL**

Fall height	520 mm
Certificates	EN 1176-1, 2:2008 TÜV
User age	Over 1 years
Installation time, 2 people	1,5h
Mounting alternatives	Deep and surface mounting



1:200

220505
PYRAMID CLIMBER

Safety zone > 600 mm	17.1m ²
Fall height	1510 mm
Certificates	EN 1176-1, 2:2008 TÜV
User age	Over 4 years
Installation time, 2 people	5,5h
Mounting alternatives	Deep and surface mounting

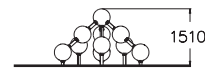
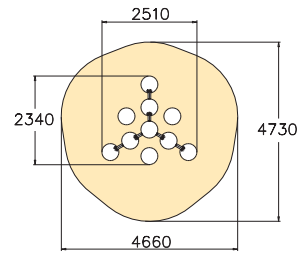

1:200

220545
VAULT BOX M

Safety zone > 600 mm	18.2m ²
Fall height	960 mm
Certificates	EN 1176-1, 2:2008 TÜV
User age	Over 10 years
Installation time, 2 people	3,5h
Mounting alternatives	Deep and surface mounting

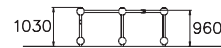
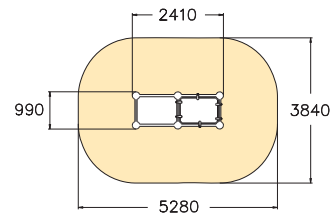

1:200

220546
VAULT BOX M

Safety zone > 600 mm	18.2m ²
Fall height	960mm
Certificates	EN 1176-1, 2:2008 TÜV
User age	Over 10 years
Installation time, 2 people	3,5h
Mounting alternatives	Deep and surface mounting

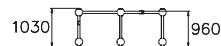
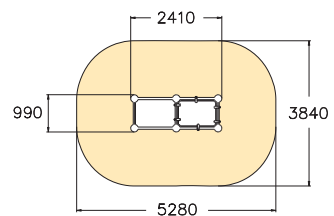

NEW PRODUCT!

**220538
PRECISION BAR LONG**



**220537
PRECISION BAR LONG**



Fall height	170 mm
Certificates	EN 1176-1, 2:2008 TÜV
User age	Over 6 years
Installation time, 2 people	1h
Mounting alternatives	Deep and surface mounting

1:200

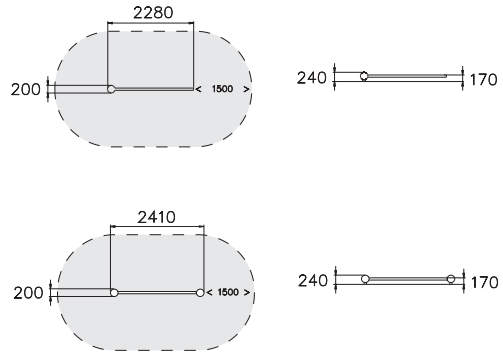

**220540
PRECISION BAR**

Fall height	170 mm
Certificates	EN 1176-1, 2:2008 TÜV
User age	Over 6 years
Installation time, 2 people	1.0h
Mounting alternatives	Deep and surface mounting

1:200

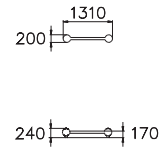

**220539
PRECISION BAR (EXTRA PART)**

Fall height	170 mm
Certificates	EN 1176-1, 2:2008 TÜV
User age	Over 6 years
Installation time, 2 people	1h
Mounting alternatives	Deep and surface mounting

1:200

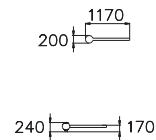



1:200

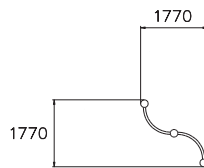

220541
PRECISION BEAM

Fall height	380 mm
Certificates	EN 1176-1, 2:2008 TÜV
User age	Over 6 years
Installation time, 2 people	1,5h
Mounting alternatives	Deep and surface mounting



1:200

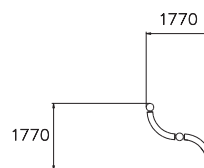

220542
PRECISION BEAM WIDE

Fall height	380 mm
Certificates	EN 1176-1, 2:2008 TÜV
User age	Over 6 years
Installation time, 2 people	2h
Mounting alternatives	Deep and surface mounting



1:200

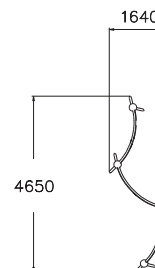

220543
PRECISION CURVE

Fall height	490 mm
Certificates	EN 1176-1, 2:2008 TÜV
User age	Over 6 years
Installation time, 2 people	2h
Mounting alternatives	Deep and surface mounting



1:200

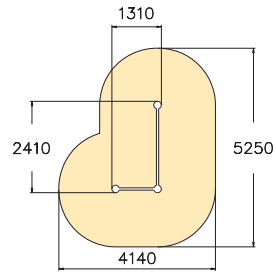

220547

VAULT RAILS S

Safety zone > 600 mm	17m ²
Fall height	650 mm
Certificates	EN 1176-1, 2:2008 TÜV
User age	Over 6 years
Installation time, 2 people	2h
Mounting alternatives	Deep and surface mounting



1:200

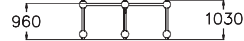
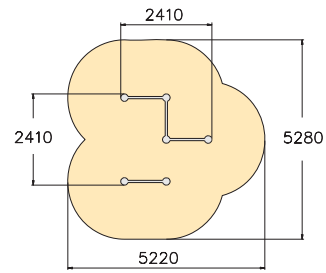

220548

VAULT RAILS M

Safety zone > 600 mm	21.9m ²
Fall height	960 mm
Certificates	EN 1176-1, 2:2008 TÜV
User age	Over 10 years
Installation time, 2 people	3,5h
Mounting alternatives	Deep and surface mounting



1:200

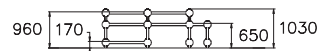
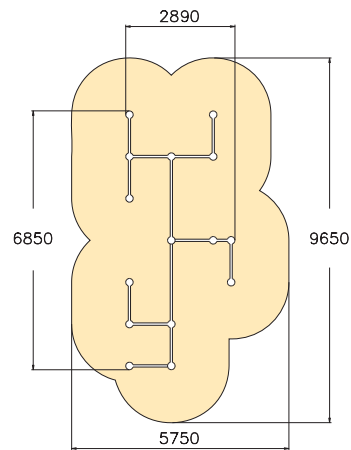

220549

VAULT RAILS L

Safety zone > 600 mm	45.2m ²
Fall height	960 mm
Certificates	EN 1176-1, 2:2008 TÜV
User age	Over 10 years
Installation time, 2 people	8,5h
Mounting alternatives	Deep and surface mounting

NEW PRODUCT!



1:200

**220551
VAULT CAGE S**

Safety zone > 600 mm	17.2m ²
Fall height	1430mm
Certificates	EN 1176-1, 2:2008 TÜV
User age	Over 6 years
Installation time, 2 people	3,5h
Mounting alternatives	Deep and surface mounting

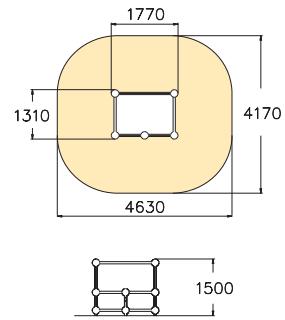

NEW PRODUCT!



1:200

**220560
WALL RUN XS**

Safety zone > 600 mm	11.7m ²
Fall height	710mm
Certificates	EN 1176-1, 2:2008 TÜV
User age	Over 6 years
Installation time, 2 people	1h
Mounting alternatives	Deep and surface mounting

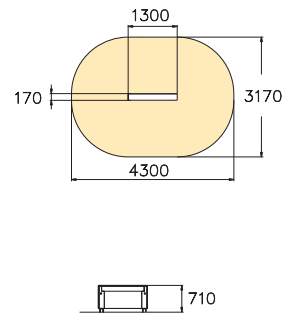

NEW PRODUCT!



1:200

**220564
WALL COMBINATION M**

Safety zone > 600 mm	15.4m ²
Fall height	1320mm
Certificates	EN 1176-1, 2:2008 TÜV
User age	Over 10 years
Installation time, 2 people	1,5h
Mounting alternatives	Deep and surface mounting

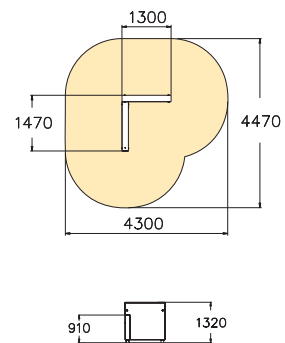

NEW PRODUCT!



1:200

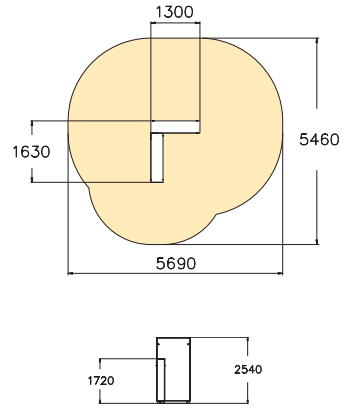

220568
WALL COMBINATION L

Safety zone > 600 mm	24.7m ²
Fall height	2540mm
Certificates	EN 1176-1, 2:2008 TÜV
User age	Over 10 years
Installation time, 2 people	3h
Mounting alternatives	Deep and surface mounting

Additional wall products are to be found on our website, for e.g 220561, 220562, 220565 and 220566.

1:200

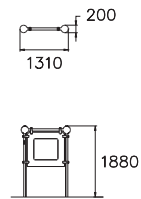

220590
INFO SIGN

Installation time, 2 people	1h
Mounting alternatives	Deep and surface mounting

Info sign includes:

- Training instructions
- Link to the tutorial videos on the web
- Space for general information of the site.

TECHNICAL DATA

PRODUCT NUMBER	PRODUCT NAME	Equipment dimensions p x l x k (mm)	Largest part (mm)	Heaviest part (kg)	Minimum space p x l x k (mm)	Max. free fall height (mm)	Safety zone > 600mm (m ²)	Page
220501	PRECISION BALL (YELLOW)	450x450x520	450	11	450x450x2320	520		26
220502	PRECISION BALL (GRAY)	450x450x520	450	11	450x450x2320	520		26
220503	LAUNCH BOX (GREY)	990x990x720	710	13.5	3840x3840x2450	650	12.8	26
220505	PYRAMID CLIMBER	2510x2340x1510	1206	67.25	4730x4660x3310	1510	17.1	27
220510	GIBBONSWING S	4630x3520x1830	2148	7.5	7430x6320x3630	1760	32	22
220511	GIBBONSWING M	4630x4630x2300	2148	7.5	7430x7430x4100	2230	39.5	22
220513	GIBBONSWING L	5660x6090x2650	3105	11	6790x7630x4450	2650	44.4	22
220517	SPIDER CAGE XS	2880x1770x1500	1493	16.9	5740x4590x2760	1435	22.1	23
220520	SPIDER CAGE S	2420x2420x2290	1493	27.5	6230x5740x4090	2210	30.4	23
220523	SPIDER CAGE M	3520x3520x2600	2278	53	7750x7070x4400	2530	45.4	23
220524	SPIDER CAGE M	3520x4110x2600	2278	53	7730x7750x4030	2530	48.7	25
220526	SPIDER CAGE L	7960x4630x2600	2278	53	10950x8860x4400	2530	72.7	24
220530	TIC-TAC CUBE S	2020x1780x1550	1034	24.7	4570x4360x3350	1550	15	24
220531	TIC-TAC CUBE M	2420x2400x2190	1500	24.7	4850x4630x3990	2190	17.8	24
220532	TIC-TAC CUBE L	2390x2930x2180	2148	24.7	4630x5730x3990	2180	20.2	26
220537	PRECISION BAR LONG EXTRA	2280x200x240	2148	7.5	2280x200x2040	170		28
220538	PRECISION BAR LONG	2410x200x240	2148	7.5	2410x200x2040	170		28
220539	PRECISION BAR EXTRA	1170x200x240	1034	3.6	1170x200x2040	170		28
220540	PRECISION BAR	1310x200x240	1034	3.6	1310x200x2040	170		28
220541	PRECISION BEAM	1770x1770x450	774	4.2	4730x4330x2250	380		29
220542	PRECISION BEAM WIDE	1770x1770x450	1013	4.2	4730x4330x2250	380		29
220543	PRECISION CURVE	4650x1640x490	1100	6	6990x4200x2290	490		29
220545	VAULT BOX M	2410x990x1030	1034	17	5280x3840x2830	960	18.2	27
220546	VAULT BOX M	2410x990x1030	1034	17	5280x3840x2830	960	18.2	27
220547	VAULT RAILS S	2410x1310x720	2148	7.5	5250x4140x2520	650	17	30
220548	VAULT RAILS M	2410x2410x1030	1034	3.6	5280x5220x2830	960	21.9	30
220549	VAULT RAILS L	6850x2890x1030	2148	7.5	9650x5750x2830	960	45.2	30
220551	VAULT CAGE S	1770x1310x1500	1493	7.5	4630x4170x2450	1430	17.2	31
220552	VAULT CAGE M	2420x1770x1813	2148	7.5	5540x4790x2760	1745	23.6	25
220560	WALL XS	1300x170x710	1300	90.5	4300x3170x2510	710	11.7	31
220561	WALL S	1300x170x910	1300	107.8	4300x3170x2710	910	11.7	
220562	WALL M	1300x170x1310	1310	143.1	4300x3170x2710	1310	11.7	
220564	WALL COMBINATION M	1300x1470x1320	1310	143.1	4300x4470x3120	1320	15.4	31
220565	WALL L	1300x320x1720	1720	287.7	4590x3610x3520	1720	14.3	
220566	WALL XL	1300x320x2540	2540	382.5	5690x4710x4340	2540	22.6	
220568	WALL COMBINATION L	1300x1630x2540	2540	382.5	5690x5460x4340	2540	24.7	32
220590	INFO SIGN	1310x200x1880	2148	25.8	1310x200x3680			32



WARRANTY PERIODS

The warranty covers structural strength, materials and manufacturing faults. The warranty does not cover faults resulting from negligent installation and maintenance, normal wear and tear, and slight fading of colours.

20 years

- steel components
- elements made of high pressure laminate (HPL)

15 years

- aluminium components
- glass fibre reinforced plastic components

10 years

- surface finish of steel components; hot galvanisation, LappCoat
- surface finish of aluminium components, anodising, painting

3 years

- rubber and rubber-coated parts, and polyurethane parts







LAPPSET GROUP OY LTD

P.O. BOX 8146

FI-96101 ROVANIEMI

Tel. +358 207 750 100

Fax +358 207 750 101

lappset@lappset.com

www.lappset.com

www.facebook.com/LappsetGroup

www.youtube.com/lappsetgroup